

(A) Colector drenaje 1"
1" Drainage manifold

(B) Colector entrada 8"
8" Inlet manifold

(C) Colector salida 8"
8" Outlet manifold

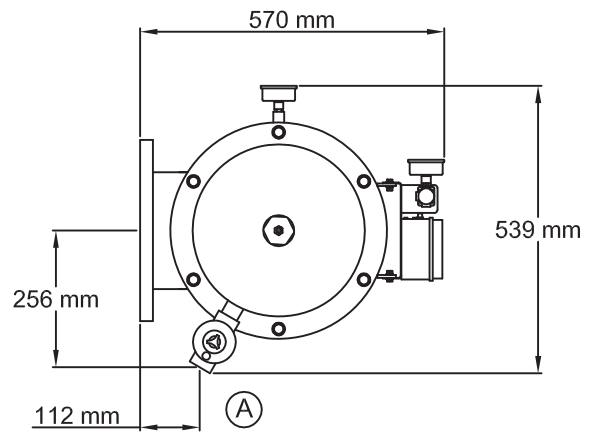

AZUD LUXON LCA 4800/8

SCALE S/E A4 FORMAT	MATERIAL:	RESPONS.: M. Martínez	AZUD
	UNITS: mm.	REVISION: 00	
	FILE: Azud_luxon_LCA_4800-8.dwg	12/04/2012	